

BONNET GUARD

INSTALLATION INSTRUCTIONS

FOR: HILUX VIGO 2005

BOSSCO AUTO
ACCESSORIES

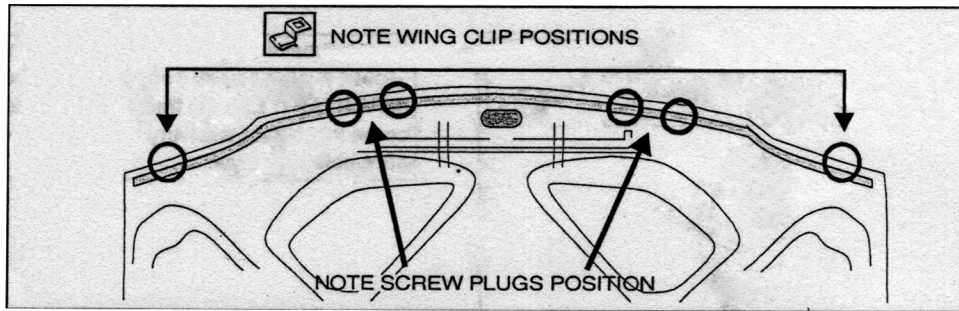

Note that some Hilux mode are fitted with rubber trim on the underside of the bonnet, as shown below. If your vehicle is NOT fitted with the rubber trim, disregard references to the rubber trim. Fitment of the Bonnet Protector is identical, with that exception.

STEP 1

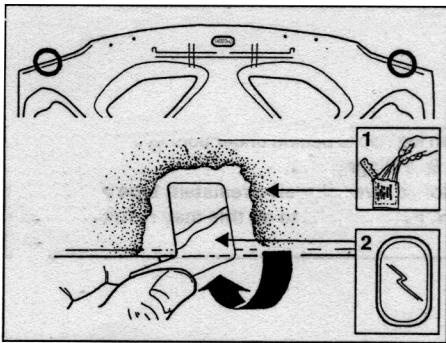

Open & thoroughly clean and dry the bonnet. Trial fit Bonnet Protector centrally onto bonnet. If the vehicle is fitted with rubber trim, pull the rubber trim away from the bonnet. Note the rubber trim retaining plugs that correspond to the four slots in Bonnet Protector tags. Also note the two areas of the bonnet which correspond to the holes in the wings of the Bonnet Protector. Remove Bonnet Protector. At the previously noted metal wing clip positions, clean these areas with the alcohol wipe provided and remove any residue with a dry clean cloth. Adhere the abrasive resistant tape to the areas as shown. Fold tape over so approximately half of each strip is adhered to the outside and half to the underside of bonnet. **IMPORTANT:** Ensure that the abrasive resistant tape is positioned directly below the slots in Bonnet Protector.

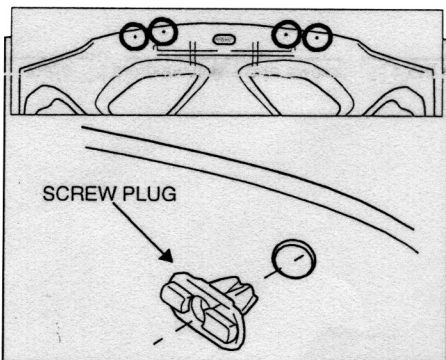

STEP 2

Remove the retaining rubber trim plugs and insert the screw plugs provided.

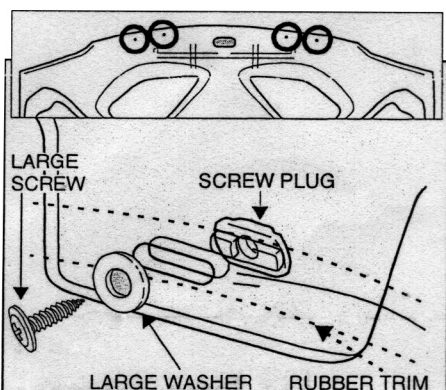

STEP 3

Re-fit the Bonnet Protector centrally and ensure the tag of Bonnet Protector is between the rubber trim and bonnet. Ensure the raised end of the screw plugs locate in the slots of Bonnet Protector tags. Secure the Bonnet Protector with the large screws and large washers provided. **DO NOT OVER TIGHTEN SCREWS.**

BONNET GUARD INSTALLATION INSTRUCTIONS

FOR:HILUX VIGO 2005

BOSSCO AUTO
ACCESSORIES

STEP 4

Fit the nut insert into the wing clips, as shown in

IMPORTANT: Please ensure that the plastic nut insert correctly engages the square hole of the clip as shown. If the thread insert is not fully engaged it may pull away from the clip during use. To ensure full engagement, please use a pair of plies to flatten the head of the insert against the clip, as shown above.

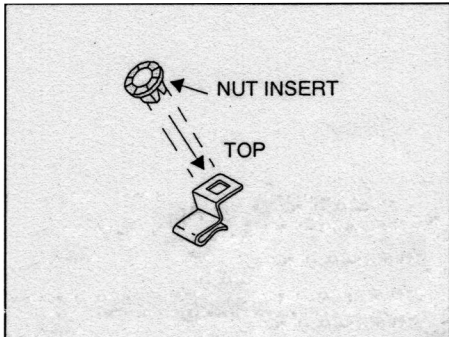

STEP 5

Install metal wing clips ensuring that the bottom leg hooks behind under bonnet sealant and top section is aligned with hole in Bonnet Protector.

IMPORTANT: Ensure that the clips are positioned over abrasive resistant tape and do not come in contact with any of the bonnet's pain work. Failure to do this may result in perma-nent paint damage.

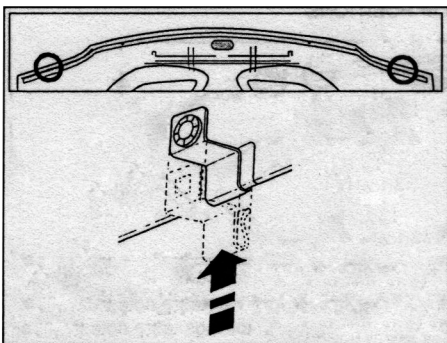

STEP 6

Secure the Bonnet Protector to wing clips with the small screws and small washers provided.

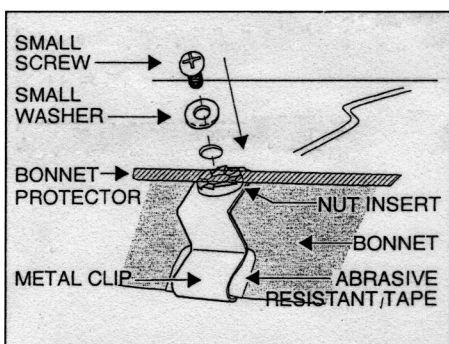

Do not use automatic car wash.



Clean Bonnet Protector with a mild detergent and water solution.

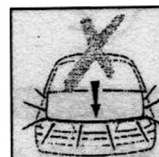

Do not slam bonnet.



Do not use abrasive cleaners