









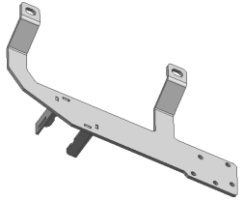

## E-Tailgate lock Installation Instruction

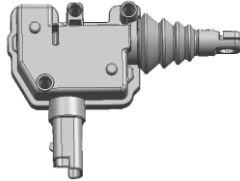
### ISUZU D-MAX 2021/ MAZDA BT50 2021(With key hole)

#### CAUTION:

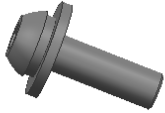
1. The figures here are for reference only and may have differences with the actual product you received, however they share the same assembly way.
2. Please read the instruction completely for easy installation, which will also help you to avoid scratches or other potential damages to your appealing car.

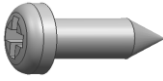
#### PART LIST:

NO.	QTY	NAME	NO.	QTY	NAME
①	1	 Bracket 1	②	1	 Bracket 2
③	1	 Actuator	④	1	 Wire harness (Universal)
⑤	2	 T-Shaped clamp (wire harness 0.2-0.5)	⑥	1	 Allen wrench S=4
⑦	2	 Button head bolt assembly M6_20	⑧	1	 Flat washer D8_22_2
⑨	3	 Phillip tapping screw ST4.8_16	⑩	1	 Button head bolt M6_20
⑪	1	 Hex flange nut M6			

Item NO.: PW039937

Name: E-Tailgate lock for ISUZU D-MAX 2021 (With key hole)

---

**STEP ONE: Brackets Installation:**

Remove the bedliner plate & steel cover plate on tailgate by loosening the screws.



**Installation Figure:**

As below photo shows, install ① bracket 1, ② bracket 2 and ⑤ actuator with ⑧ ⑨ ⑩ ⑪ ⑫.

---

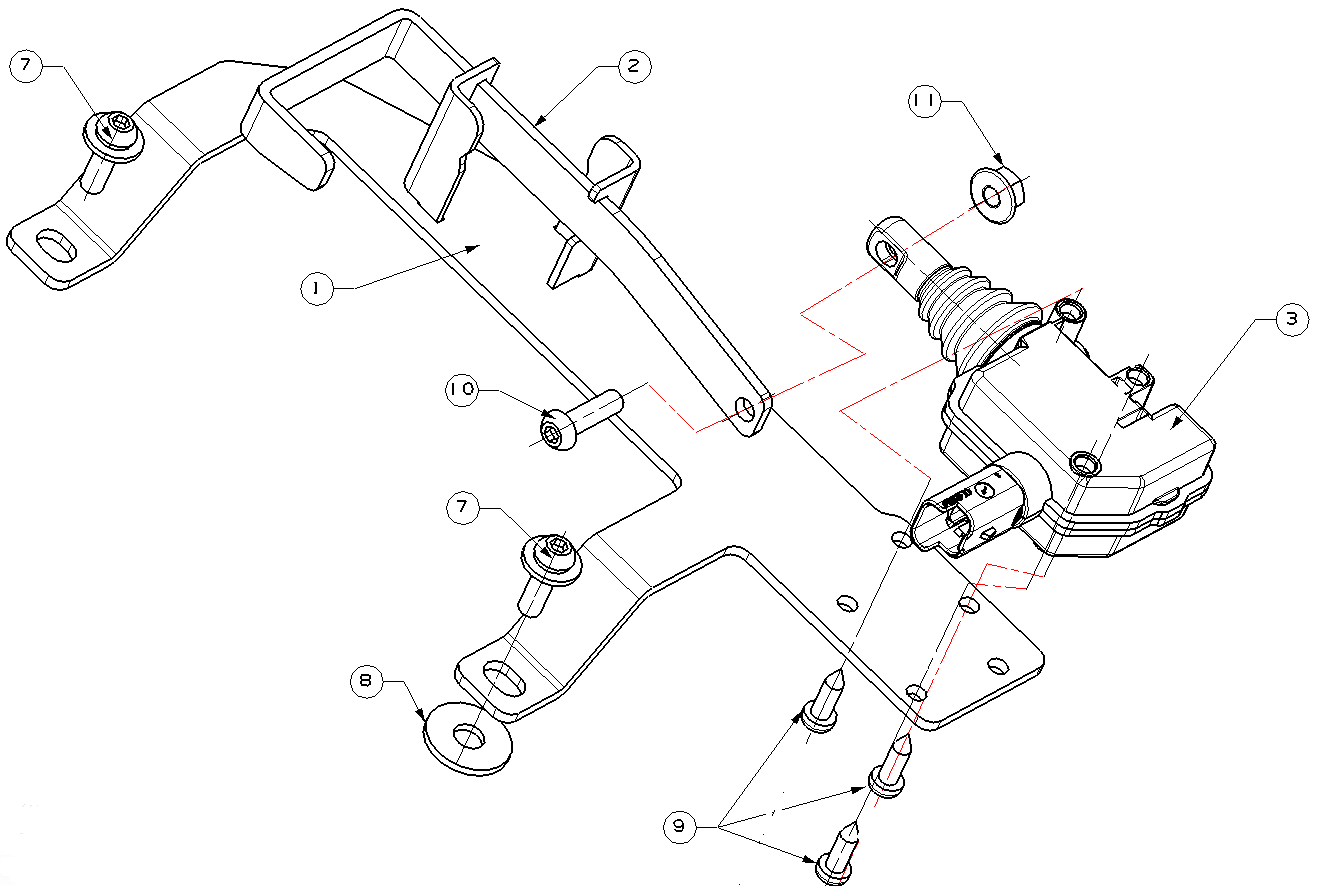

Item NO.: PW039937

Name: E-Tailgate lock for ISUZU D-MAX 2021 (With key hole)

---

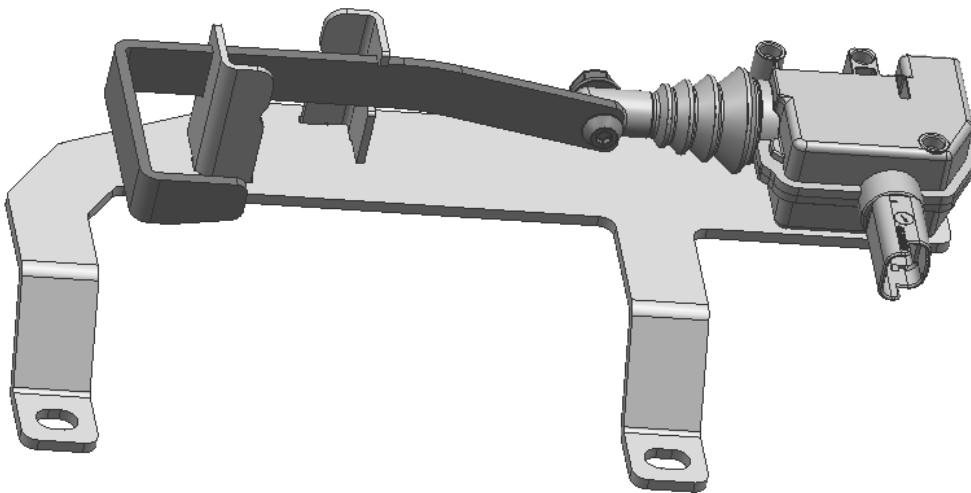

Remove the two original screws, as below picture shows.

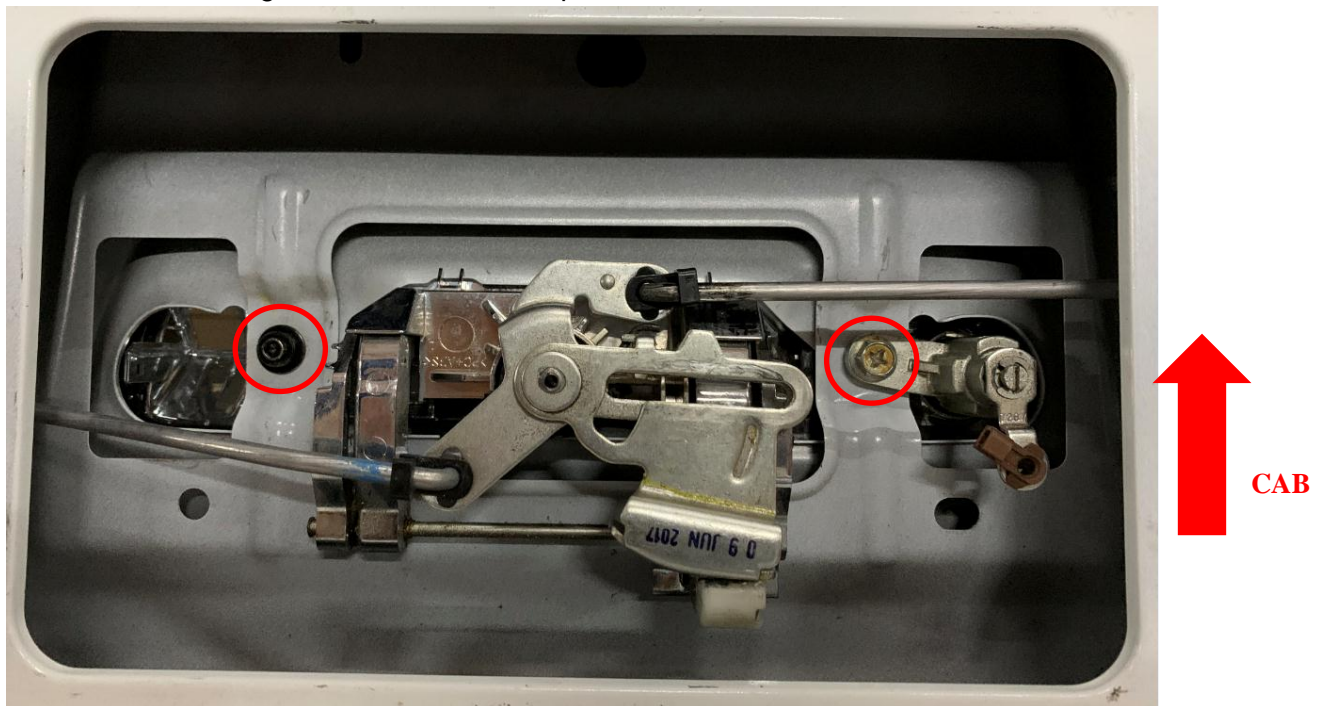

Install the bracket assembly into the tailgate, fasten it with the two original screws mentioned above.

Install ③ bracket 3 and fasten it with ⑧ ⑨ ⑪ :

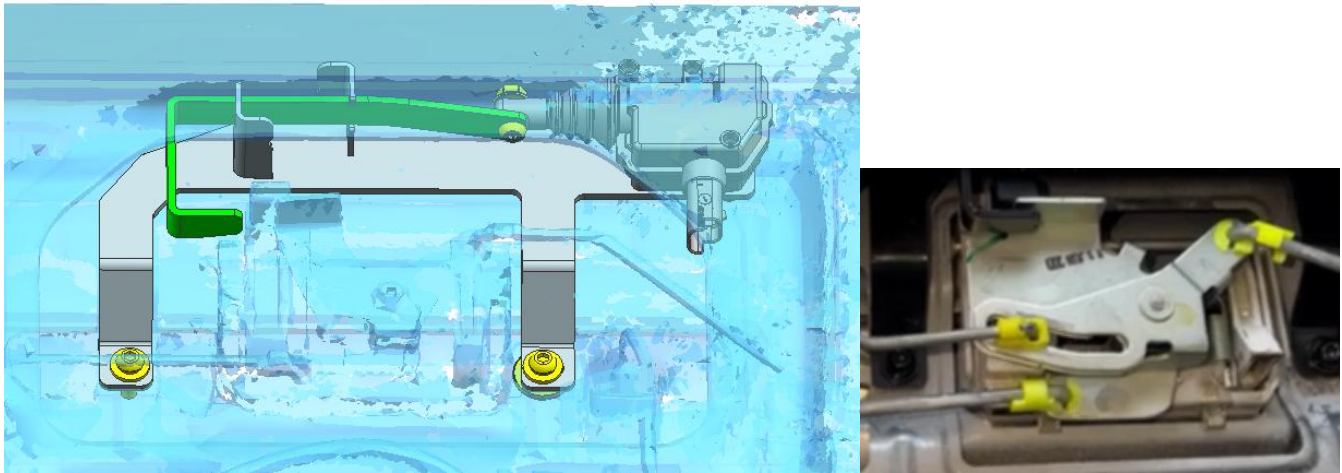

Before reinstall the cover plate on tailgate, please test the locking function.

● Wiring harness connection:

1. Connect the wiring to the actuator the route the ④ actuator wiring harness out of the tailgate and underneath the vehicle.

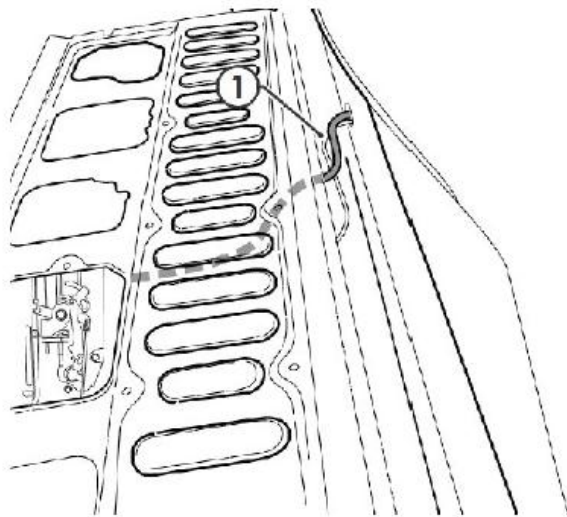

2. Route the wiring harness along the chassis rail to the driver seat.

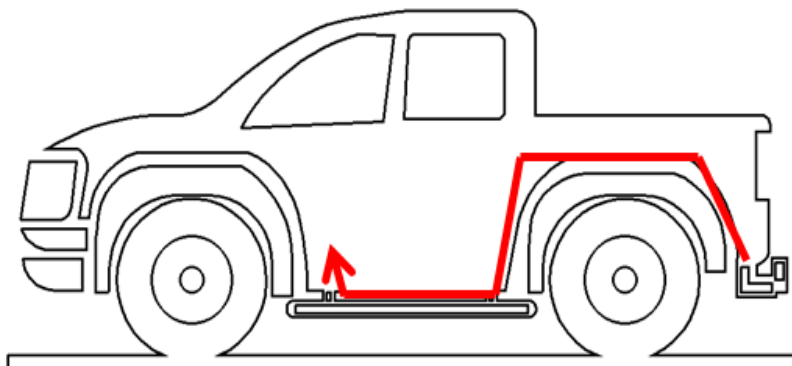

3. Route the wiring harness along the chassis rail to the driver seat.

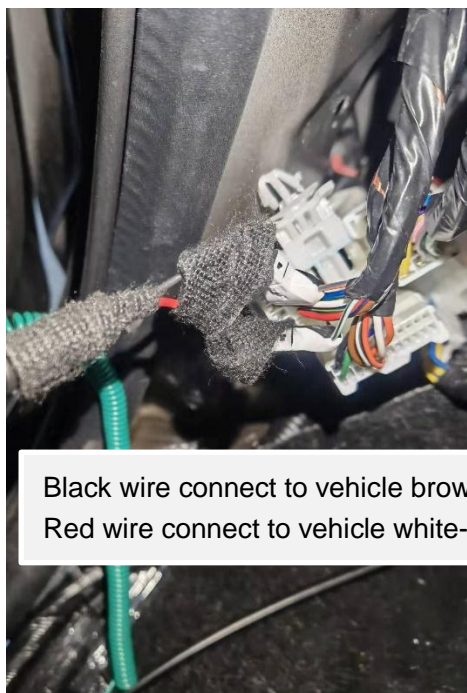

Black wire connect to vehicle brown-blue wire  
Red wire connect to vehicle white-green wire

4. Please test the locking function before reinstalling the decorating board on driver seat.
5. After completing the above installation, use the remote control to check whether the installation is ok, and then restore the tailgate cover to its original position.

