

INSTALLATION INSTRUCTIONS

Front Bumper Bar Bullbar suitable for Isuzu D-max 2012-2016

Before Installation

- Please read the instructions completely and carefully
- The figures here are for reference only and may have differences with the actual product you receive, however they share the same method of assembly.







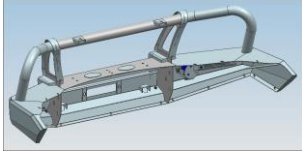
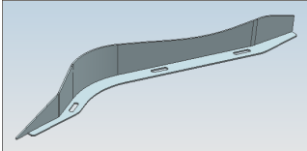
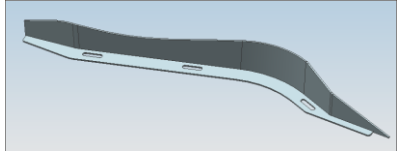
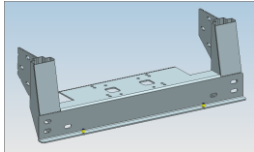
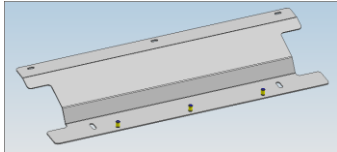
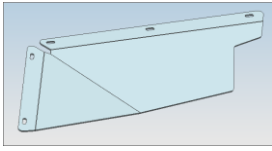
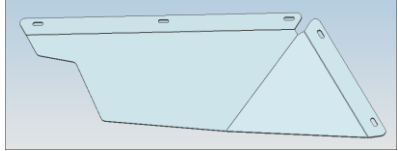
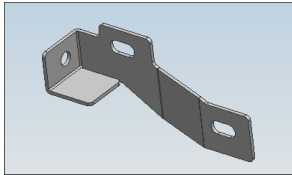
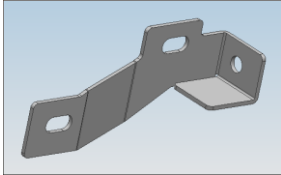



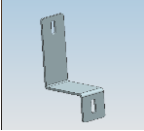

Care and Cleaning

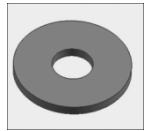
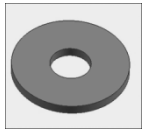
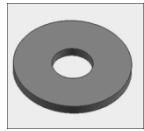
- Mild soap may be used to clean the product.
- Please periodically check and retighten all hardware to ensure maximum life and durability.

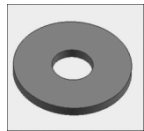
Parts list

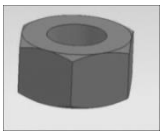
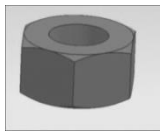
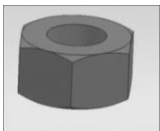
NO.	QTY	NAME	NO.	QTY	NAME
①	1	Rubber Strip (2000MM)	②	1	 Main bull bar Assembly
③	1	 Side wing body (L)	④	1	 Side wing body (R)
⑤	1	 Winch Frame	⑥	1	 Central Skid plate
⑦	1	 Skid plate (L)	⑧	1	 Skid plate (R)
⑨	1	 Bracket(L)	⑩	1	 Bracket(R)

INSTALLATION INSTRUCTIONS

⑪	1		⑫	21	
		Middle Mesh Bracket			Spring Washer D6
⑬	5		⑭	4	
		Spring Washer D8			Spring Washer D10
⑮	8		⑯	1	
		Spring Washer D12			Large Washer D6
⑰	25		⑱	5	
		Large Washer D6			Large Washer D8
⑲	8		⑳	16	
		Large Washer D10			Large Washer D12
㉑	3		㉒	1	Button Head Allen Bolt M6_25
		Super large Washer D6			
㉓	8		㉔	4	
		Hex Nut M6			Hex Nut M10
㉕	8		㉖	20	
		Hex Nut M12			Hex Bolt M6_20
㉗	5		㉘	4	
		Hex Bolt M8_25			Hex Bolt M10_80

INSTALLATION INSTRUCTIONS

②⑨	8				
		Hex Bolt M12_40			

Installation Steps

Installation Fig.

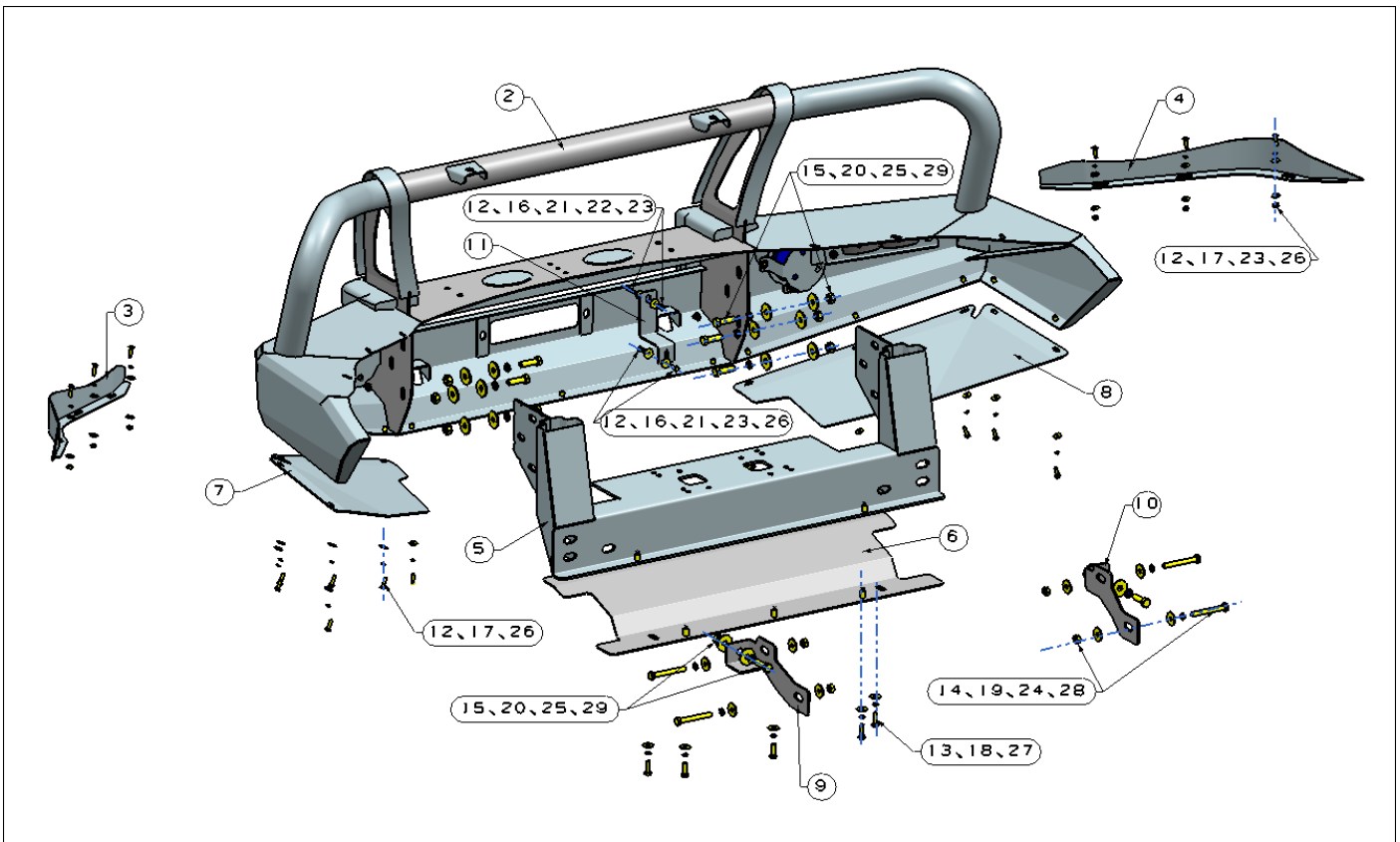

Step 1: Install the ⑤ winch frame on vehicle as above picture. You can install the winch now if you need.

Step 2: Install the ⑨⑩ Brackets on vehicle as above picture, then connect the brackets and winch frame.

Step 3: Install the ①③④ on the bull bar as above picture.

Step 4: Connecting the installed bull bar on winch frame.

Step 5: Install the ⑥⑦⑧ on the bull bar as above picture.

Step 6: Install middle mesh bracket & middle mesh on the vehicle.

Step 7: Test and make sure that the guard is steadily fixed, fully tighten all hardware.

INSTALLATION INSTRUCTIONS

NOTE

Any damage and loss caused by improper installation and application, goes beyond our quality warranty.